



SINGLE STAGE DIAPHRAGM SENSED ABSOLUTE PRESSURE *Pressure Reducing Regulators*

2550A SERIES

PREMIER INDUSTRIES

1590 99th Ln NE,
Minneapolis, MN 55449
763-786-4020



MADE IN THE USA

Minneapolis, MN

DESCRIPTION

Premier 2550A Series regulators are single stage, diaphragm sensed, increased sensitivity, absolute pressure regulators. They can be used to reduce supply pressures up to 3000 PSIG (206.84 bar) into a vacuum environment for sub-atmospheric pressure control. Premier 2550A Series regulators feature a large stainless steel diffusion-resistant metal diaphragm, Cv 0.08, and optional panel mount or bottom mount.

FEATURES

- Full vacuum sub-atmospheric pressure control
- Large stainless steel diaphragm for increased sensitivity and reduced droop
- Stainless steel diaphragm minimizes inboard diffusion of air into the regulator
- Optional panel mount or bottom mount
- Captured bonnet vent
- 15 micron sintered inlet filter
- 3000 PSIG (206.84 bar) max inlet pressure
- Cv 0.08
- Machined bar stock body, bonnet, and piston eliminates porosity found in castings

2550A SERIES

SINGLE STAGE DIAPHRAGM SENSED ABSOLUTE PRESSURE *Pressure Reducing Regulators*

SPECIFICATIONS

- **MAXIMUM INLET PRESSURE:** 3000 PSIG (206.84 bar)
- **CONTROL PRESSURE RANGES:**
 - 50 mm Hg absolute - 15 psig (30" HG-30 psig)
 - ***50 mm Hg absolute = 28" Hg*
- **FLOW (Cv):** 0.08

MATERIALS OF CONSTRUCTION

- **BODY:**
 - 316 Stainless Steel
- **BONNET:**
 - SAE 360 Brass/Nickel Plated
- **DIAPHRAGM:**
 - Elgiloy®
- **DIAPHRAGM SEAL:** PTFE
- **VALVE SEAT:** PTFE

PORTING

- **INLET:**
 - 1/4-18 NPT
- **OUTLET:**
 - 1/4-18 NPT

OPTIONS

- Gauges (2 inch diameter)
- Private label
- Panel mounting nut (P/N: 50-10240)
- Bottom mounting holes

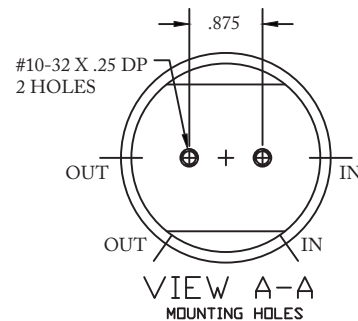
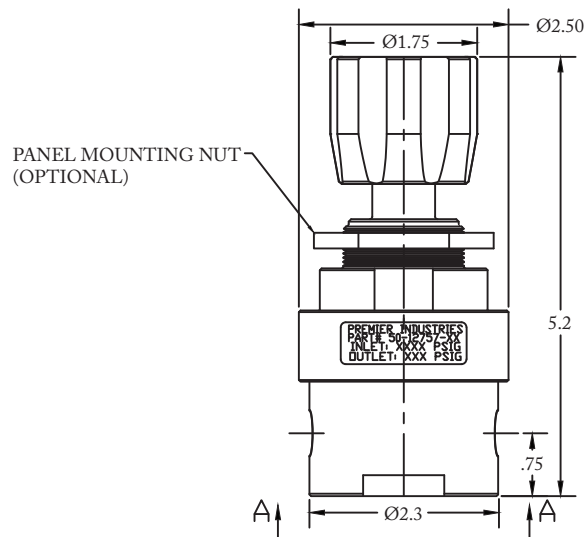
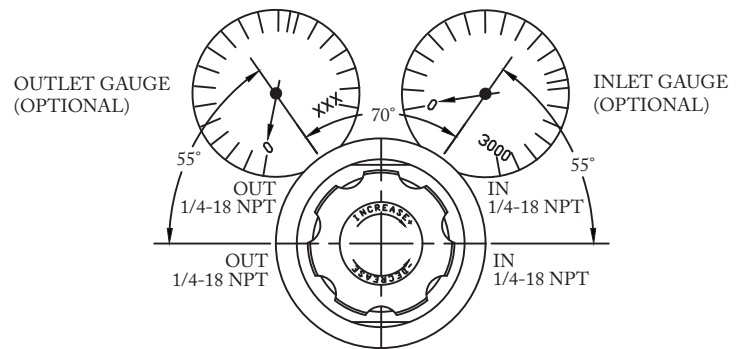

(Part number 50-12757 shown above)















**SINGLE STAGE
DIAPHRAGM SENSED
ABSOLUTE PRESSURE**
Pressure Reducing Regulators



PART #	-	1	2	3	4	5
50-12757	-					

1	BODY MATERIAL & FINISH
2	316 Stainless Steel, cleaned per spec #515
2	OUTLET PRESSURE
0	0-50 mm Hg Absolute-15 psig (30" HG-30 psig)
3	GAUGES (OPTIONAL)
Blank	no gauges (standard)
A	2" diameter, inlet only, stainless steel wetted gauge
B	2" diameter, outlet only, stainless steel wetted gauge
C	2" diameter, inlet & outlet, stainless steel wetted gauges
4	PANEL MOUNTING NUT (optional)
5	Mounting nut
8	No nut (standard)

5	PORTING OPTIONS
Blank	 (*C, Standard)
A	
B	
D	
E	
F	
G	
H	
I	
J	
K	
L	
S	