



DIAPHRAGM SENSED GAS CARTRIDGE COMPATIBLE *Pressure Reducing Regulators*

2300C SERIES

PREMIER INDUSTRIES

1590 99th Ln NE,
Minneapolis, MN 55449
763-786-4020



MADE IN THE USA

Minneapolis, MN

DESCRIPTION

The 2300C Series regulators are compact, single stage, diaphragm sensed regulators, designed for use with disposable gas cartridges. The 2300C Series features a 303 stainless steel piercing tip, integrated relief valve, and a selection of adapters for various threaded and unthreaded disposable gas cartridges. These regulators are designed to control pressures up to 3500 PSIG (241.3 bar), with a flow capacity (Cv) of 0.04. The 2300C is lightweight, economical, and reliable for all your disposable gas cylinder needs.

The Premier 2300C is suitable for common cartridge gases: carbon dioxide, argon, nitrogen gas, helium, air, nitrous oxide (brass option).

FEATURES

- Specifically designed for use with disposable gas cartridges
- Robust stainless steel piercing tip
- Integrated relief valve
- Compact size
- Very competitive pricing
- Machined bar stock body, and bonnet eliminates porosity found in castings
- Adjusting knob with locking-nut



**DIAPHRAGM SENSED
GAS CARTRIDGE COMPATIBLE**
Pressure Reducing Regulators



SPECIFICATIONS

- **MAX INLET PRESSURE:** 3500 PSIG (241.3 bar)
- **OUTLET PRESSURE / RELIEF PRESSURE:**
 - 0 - 15 PSIG (0-1.03 bar) / 60 PSIG (4.14 bar)
 - 0 - 30 PSIG (0-2.07 bar) / 60 PSIG (4.14 bar)
 - 0 - 60 PSIG (0-4.14 bar) / 90 PSIG (6.21 bar)
 - Consult factory for other options
- **FLOW CAPACITY (Cv):** 0.04

MATERIALS OF CONSTRUCTION

- **BODY & BONNET OPTIONS:**
 - 6061-T6 Aluminum, Clear Anodize
 - SAE 360 Brass, Bright Dip
- **INLET ADAPTER:**
 - SAE 360 Brass, Bright Dip (for threaded)
 - 303 Stainless Steel and Aluminum, Anodized (for cup adapter)
- **PIERCING TIP:** 303 Stainless Steel
- **DIAPHRAGM:** Fabric reinforced neoprene
- **O-RING MATERIAL:** Nitrile
- **MAIN VALVE HOUSING:** Brass
- **MAIN VALVE SPRING:** Stainless Steel
- **MAIN VALVE SEAL:** Nitrile
- **CARTRIDGE GASKET:** Polyurethane
- **RELIEF VALVE:** Stainless steel
- **OTHER NON-WETTED COMPONENTS:**
 - brass/aluminum/spring steel

PORTING (1, 2, and 3 port options)

- **STANDARD INLET:**
 - CARTRIDGE ADAPTER WITH PIERCING TIP
 - 3/8-24 UNF
 - 7/16-20 UNF
 - 1/2-20 UNF
 - 5/8-18 UNF
 - 5/8-18 UNF- extra long
 - cup adapter for 16g CO2 unthreaded cartridges
- **OTHER PORTS:**
 - 1/8-27 FNPT

OPTIONS

- Anodized colors for aluminum bodies and bonnets
- Private label

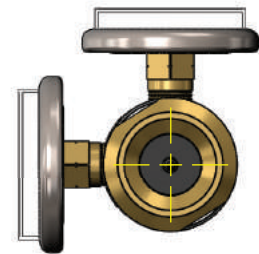
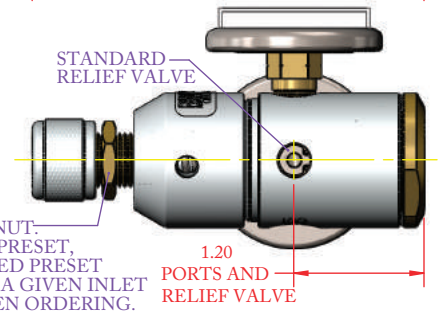
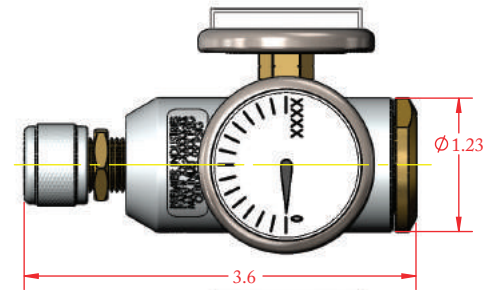

THREADED CARTRIDGE ADAPTER

(Part number shown above: 50-12607 - Standard design)



UNTHREADED CARTRIDGE ADAPTER CUP







**DIAPHRAGM SENSED
GAS CARTRIDGE COMPATIBLE**
Pressure Reducing Regulators



PART #	-	1	2	-	3	4	-	5
50-12607	-			-			-	

1	BODY & BONNET MATERIAL & FINISH
1	6061-T6 Aluminum <i>Clear Anodize</i>
2	SAE 360 Brass <i>Bright Dip</i>
2	INLET CARTRIDGE ADAPTER
1	3/8-24 UNF
2	7/16-20 UNF
3	1/2-20 UNF
4	5/8-18 UNF
5	5/8-18 UNF - extra long
6	Cup adapter for 16g CO ₂ unthreaded cartridges
3	OUTLET PRESSURE / RELIEF PRESSURE
1	0 - 15 PSIG (0-1.03 bar) / 60 PSIG (4.14 bar)
2	0 - 30 PSIG (0-2.07 bar) / 60 PSIG (4.14 bar)
3	0 - 60 PSIG (0-4.14 bar) / 90 PSIG (6.21 bar)

4	PORTING
1	"S*" porting 
2	"H*" porting 
3	"A" porting 
4	"A*" porting 
5	GAUGES
1	No gauges
2	Include gauges
<p><i>Gauges not available on "S*" porting Inlet gauge only on "H*" porting option Inlet & outlet gauge on "A" porting option Outlet gauge only on "A*" porting option</i></p>	

*Suitable for use with carbon dioxide, argon, nitrogen gas, helium, air, and nitrous oxide (brass option).
Carefully review construction materials and contact factory for use with other gases or mixtures. Contact factory if cartridge is non-standard.
Contact factory for material certifications. Fees may apply.*