



**COMPACT, LIGHT WEIGHT
SINGLE STAGE, DIAPHRAGM SENSED**
Pressure Reducing Regulators

**2300S
SERIES**

PREMIER INDUSTRIES

1590 99th Ln NE,
Minneapolis, MN 55449
763-786-4020



MADE IN THE USA
Minneapolis, MN

DESCRIPTION

Premier 2300S Series regulators are compact, single stage, diaphragm sensed, elastomer free, general purpose regulators. 2300S Series regulators feature an Elgiloy® diaphragm and are designed for inlet pressures up to 3000 PSIG (206.8 bar) and outlet pressures up to 100 PSIG (6.89 bar). These compact, general purpose, cylinder regulators offer reliable performance in a compact, lightweight design.

FEATURES

- Compact & light weight
- 3000 PSIG / 206.8 bar inlet
- Elgiloy® diaphragm
- Economical pricing
- Elastomer free for low outgassing and superior chemical compatibility
- Cv: 0.05 max
- Machined bar stock body, and bonnet eliminates porosity found in castings

*The Premier 2300S Series pressure reducing regulator's design is remarkably flexible.
Contact Premier Industries for a custom 2300S Series regulator to meet your exact needs.
Elgiloy® is a registered trademark of Elgiloy Specialty Metals Division, Combined Metals of Chicago L.L.C*

2300S SERIES

COMPACT, LIGHT WEIGHT SINGLE STAGE, DIAPHRAGM SENSED *Pressure Reducing Regulators*



SPECIFICATIONS

- **MAX INLET PRESSURE:** 3000 PSIG (206.8 bar)
- **OUTLET PRESSURE RANGES:**
 - 0 - 15 PSIG (0-1.03 bar)
 - 0 - 30 PSIG (0-2.07 bar)
 - 0 - 50 PSIG (0-3.45 bar)
 - 0 - 75 PSIG (0-5.17 bar)
 - 0 - 100 PSIG (0-6.89 bar)
- **FLOW (Cv):** 0.05

MATERIALS OF CONSTRUCTION

- **BODY/BONNET OPTIONS:**
 - SAE 360 Brass, Nickel Plated
 - 6061-T6 Aluminum, Nickel Plated
 - 303 Stainless Steel
 - 316 Stainless Steel
- **BONNET OPTIONS:**
 - SAE 360 Brass, Nickel Plated (*standard*)
 - 316 Stainless Steel
 - 303 Stainless Steel
- **DIAPHRAGM:** Elgiloy®
- **VALVE SEAT:** PTFE
- **MAIN VALVE / MAIN VALVE RETAINER:**
 - 316 Stainless Steel (*for 316 Stainless steel body option*)
 - 303 Stainless Steel (*for all other body options*)
- **SEALS:** PTFE
- **MAIN VALVE SPRING:**
 - 316 Stainless Steel

PORTING (2, 3, and 4 port options)

- **STANDARD INLET:**
 - 1/8 FNPT (1 or 2)
- **OUTLET PORTING:**
 - 1/8 FNPT (1 or 2)

OPTIONS

- **GAUGES** (1/8 FNPT Porting):
 - Stainless steel wetted components (*for stainless steel body option*)
 - Brass nickel plated wetted components (*for aluminum and brass body options*)
- **INTEGRATED RELIEF VALVE** (Optional):
 - 316 Stainless Steel valve w/ Viton® seat (*for 316 Stainless steel body option*)
 - 303 Stainless Steel valve w/ Viton® seat (*for all other body options*)
- Preset outlet pressure
- Private label

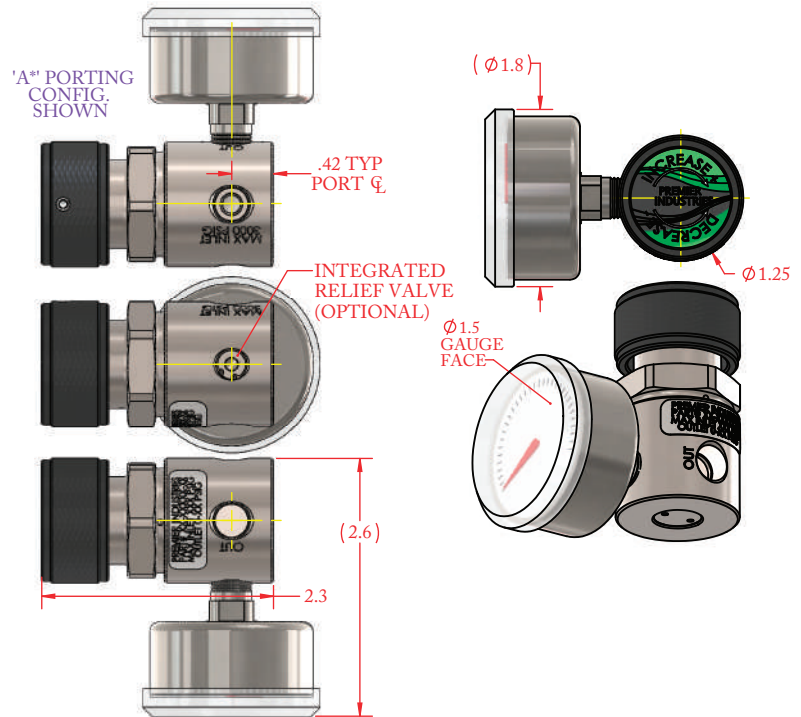

(Part number: 50-12771 shown above)

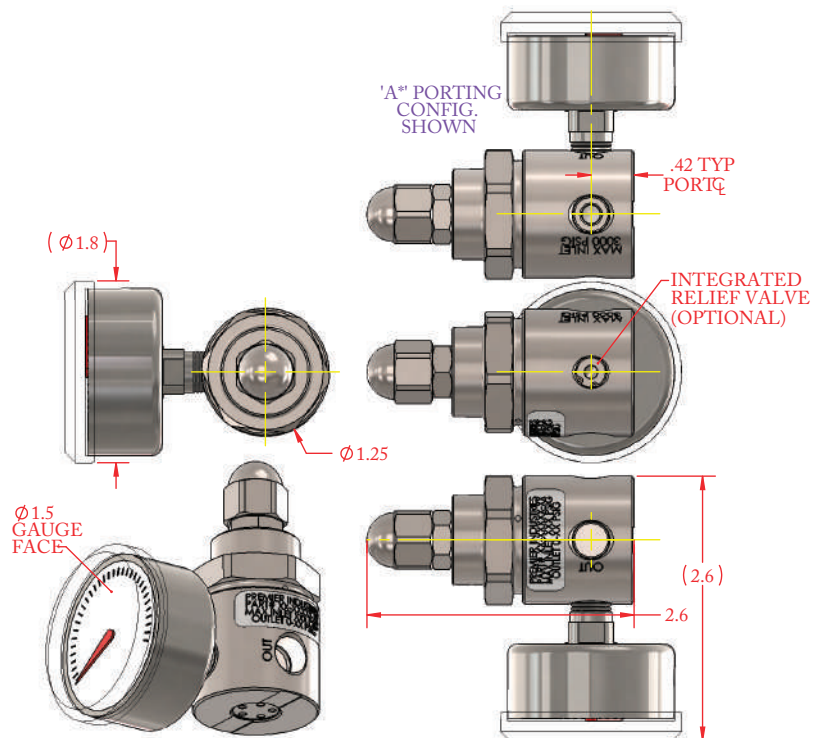











(Part number: 50-12908 shown above)



**COMPACT, LIGHT WEIGHT
SINGLE STAGE, DIAPHRAGM SENSED**
Pressure Reducing Regulators



| PART # | - | 1 | 2 | - | 3 | - | 4 | 5 | - | MODS |
|----------|---|---|---|---|---|---|---|---|---|------|
| 50-12771 | - | | | - | | - | | | - | |

| 1 | BODY/BONNET MATERIALS (MAX. INLET PRESSURE) |
|---|------------------------------------------------------------------------------------------------------------------------------------------------------------------------------------------------------------------------|
| 1 | SAE 360 Brass, Nickel Plated (body & bonnet) |
| 2 | 6061-T6 Aluminum, Nickel Plated (body) SAE 360 Brass, Nickel Plated (bonnet) |
| 3 | 303 Stainless Steel, cleaned per spec #515 (body) SAE 360 Brass, Nickel Plated (bonnet) |
| 4 | 303 Stainless Steel, cleaned per spec #515 (body) 303 Stainless Steel, cleaned per spec #515 (bonnet) |
| 5 | 316 Stainless Steel, cleaned per spec #515 (body) SAE 360 Brass, Nickel Plated (bonnet) |
| 6 | 316 Stainless Steel, cleaned per spec #515 (body) 303 Stainless Steel, cleaned per spec #515 (bonnet) |
| 7 | 316 Stainless Steel, cleaned per spec #515 (body) 316 Stainless Steel, cleaned per spec #515 (bonnet) |
| 2 | BODY PORTING |
| S | S porting, 2 port   (WITH OPTIONAL RELIEF VALVE) |
| A | A porting, 3 port   (WITH OPTIONAL RELIEF VALVE) |
| B | B porting, 3 port   (WITH OPTIONAL RELIEF VALVE) |
| G | G porting, 3 port   (WITH OPTIONAL RELIEF VALVE) |
| H | H porting, 3 port   (WITH OPTIONAL RELIEF VALVE) |
| L | L porting, 4 port  RELIEF VALVE NOT AVAILABLE ON 'L' PORTING CONFIGURATION |

| 3 | OUTLET PRESSURE | RELIEF PRESSURE IF APPLICABLE |
|--------------------------------------------------------------------------------------------------------------------------------------------------------------------------------------------------------------------------------|------------------------------------------------------------------------------------------------------------------------------------------|-------------------------------|
| 1 | 0-15 psig (0-1.03 bar) | 60 psig (4.14 bar) |
| 2 | 0-30 psig (0-2.07 bar) | 60 psig (4.14 bar) |
| 3 | 0-50 psig (0-3.45 bar) | 90 psig (6.21 bar) |
| 4 | 0-75 psig (0-5.17 bar) | 90 psig (6.21 bar) |
| 5 | 0-100 psig (0-6.89 bar) | relief valve not available |
| 4 | GAUGES | |
| 0 | None | |
| 1 | Include gauges | |
| <i>Gauges not available for 'S' porting configuration, Outlet gauge only on 'A' and 'B' configurations, Inlet gauge only on 'G' and 'H' porting configurations, Both inlet & outlet gauge on 'L' porting configuration</i> | | |
| 5 | INTEGRATED RELIEF VALVE OPTIONAL | |
| 0 | No relief valve | |
| 1 | Include relief valve | |
| <i>Relief valve not available on 'L' porting configuration. Relief valve not available if max outlet > 75 psig.</i> | | |
| MODIFICATIONS | | |
| 0 | No relief valve | |
| L | Expected max supply < 1500 PSIG* <i>*does not reduce pressure rating, optimizes performance for expected supplies under 1500 PSIG</i> | |

2300S SERIES

COMPACT, LIGHT WEIGHT SINGLE STAGE, DIAPHRAGM SENSED *Pressure Reducing Regulators*



PRESET OUTLET PRESSURE

| PART # | - | 1 | 2 | - | 3 | 4 | - | PRESET OUTLET |
|----------|---|---|---|---|---|---|---|------------------|
| 50-12908 | - | | | - | | | - | |

| 1 | BODY/BONNET MATERIALS (MAX. INLET PRESSURE) | |
|---|------------------------------------------------------------------------------------------------------------------------|---------------------------------------------------------|
| 1 | SAE 360 Brass, Nickel Plated <i>(body & bonnet)</i> | |
| 2 | 6061-T6 Aluminum, Nickel Plated <i>(body)</i> SAE 360 Brass, Nickel Plated <i>(bonnet)</i> | |
| 3 | 303 Stainless Steel, cleaned per spec #515 <i>(body)</i> SAE 360 Brass, Nickel Plated <i>(bonnet)</i> | |
| 4 | 303 Stainless Steel, cleaned per spec #515 <i>(body)</i> 303 Stainless Steel, cleaned per spec #515 <i>(bonnet)</i> | |
| 5 | 316 Stainless Steel, cleaned per spec #515 <i>(body)</i> SAE 360 Brass, Nickel Plated <i>(bonnet)</i> | |
| 6 | 316 Stainless Steel, cleaned per spec #515 <i>(body)</i> 303 Stainless Steel, cleaned per spec #515 <i>(bonnet)</i> | |
| 7 | 316 Stainless Steel, cleaned per spec #515 <i>(body)</i> 316 Stainless Steel, cleaned per spec #515 <i>(bonnet)</i> | |
| 2 | BODY PORTING | |
| S | S porting, 2 port | (WITH OPTIONAL RELIEF VALVE) |
| A | A porting, 3 port | (WITH OPTIONAL RELIEF VALVE) |
| B | B porting, 3 port | (WITH OPTIONAL RELIEF VALVE) |
| G | G porting, 3 port | (WITH OPTIONAL RELIEF VALVE) |
| H | H porting, 3 port | (WITH OPTIONAL RELIEF VALVE) |
| L | L porting, 4 port | RELIEF VALVE NOT AVAILABLE ON 'L' PORTING CONFIGURATION |

| 3 | GAUGES |
|--------------------------------------------------------------------------------------------------------------------------------------------------------------------------------------------------------------------------------|-------------------------------------------------------------------------------------------------------|
| 0 | None |
| 1 | Include gauges |
| <i>Gauges not available for 'S' porting configuration, Outlet gauge only on 'A' and 'B' configurations, Inlet gauge only on 'G' and 'H' porting configurations, Both inlet & outlet gauge on 'L' porting configuration</i> | |
| 4 | INTEGRATED RELIEF VALVE OPTIONAL |
| 0 | No relief valve |
| 1 | Include relief valve |
| <i>Relief valve not available on 'L' porting configuration. Relief valve not available if max outlet > 75 psig.</i> | |
| PRESET OUTLET PRESSURE (XXX) | |
| XXX | Specify outlet pressure preset 'XXX' in psig. Minimum 10 psig ('010'). Maximum 150 psig ('150') |
| IF REGULATOR INCLUDES A RELIEF VALVE, RELIEF SETTINGS ARE AS FOLLOWS: <i>'XXX' ≤ 30 PSIG OUT / 60 PSIG RELIEF SETTING 30 < 'XXX' ≤ 75 PSIG OUT / 90 PSIG RELIEF SETTING</i> | |
| OUTLET SET AT 2000 PSIG INLET <i>(UNLESS NOTED OTHERWISE ON WORK ORDER.)</i> | |