

2300S SERIES

Compact, Light Weight, Diaphragm Sensed
Pressure Reducing Regulators



Premier 2300S Series regulators are compact, single stage, diaphragm sensed, elastomer free, general purpose regulators. 2300S Series regulators feature an Elgiloy® diaphragm and are designed for inlet pressures up to 3000 PSIG (206.8 bar) and outlet pressures up to 100 PSIG (6.89 bar). These compact, general purpose, cylinder regulators offer reliable performance in a compact, lightweight design.

FEATURES

- Compact & light weight
- 3000 PSIG / 206.8 bar inlet
- Elgiloy® diaphragm
- Economical pricing
- Elastomer free for low outgassing and superior chemical compatibility
- Cv: 0.05 max
- Machined bar stock body, and bonnet eliminates porosity found in castings

SOME APPLICATIONS WILL REQUIRE A CUSTOM SOLUTION.
CONTACT PREMIER INDUSTRIES TO REQUEST A MODIFICATION
OR A CUSTOM DESIGN.

2300S SERIES

Compact, Light Weight, Diaphragm Sensed
Pressure Reducing Regulators

SPECIFICATIONS

- **MAX INLET PRESSURE:**
 - 3000 PSIG (206.8 bar)
- **OUTLET PRESSURE RANGES:**
 - 0 - 15 PSIG (0-1.03 bar)
 - 0 - 30 PSIG (0-2.07 bar)
 - 0 - 50 PSIG (0-3.45 bar)
 - 0 - 75 PSIG (0-5.17 bar)
 - 0 - 100 PSIG (0-6.89 bar)
- **FLOW (Cv):** 0.05

MATERIALS OF CONSTRUCTION

- **BODY OPTIONS:**
 - SAE 360 Brass, Nickel Plated
 - 316 Stainless Steel
- **BONNET OPTIONS:**
 - SAE 360 Brass, Nickel Plated (*standard*)
 - 316 Stainless Steel
- **DIAPHRAGM:** Elgiloy®
- **VALVE SEAT:** PTFE
- **MAIN VALVE / MAIN VALVE RETAINER:**
 - 316 Stainless Steel
(*for 316 Stainless steel body options*)
 - 303 Stainless Steel
(*for brass body option*)
- **SEALS:** PTFE
- **MAIN VALVE SPRING:**
 - 316 Stainless Steel

PORTING (2, 3, and 4 port options)

- **STANDARD INLET:**
 - 1/8 FNPT (1 or 2)
- **OUTLET PORTING:**
 - 1/8 FNPT (1 or 2)

OPTIONS

- **GAUGES** (1/8 FNPT Porting):
 - Stainless steel wetted components
(*for stainless steel body option*)
 - Brass nickel plated wetted components
(*for brass body options*)
- **INTEGRATED RELIEF VALVE** (*Optional*):
 - 316 Stainless Steel valve w/ Viton® seat
(*for 316 Stainless steel body options*)
 - 303 Stainless Steel valve w/ Viton® seat
(*for brass body option*)
- Preset outlet pressure
- Private label

2300S SERIES

Compact, Light Weight, Diaphragm Sensed Pressure Reducing Regulators

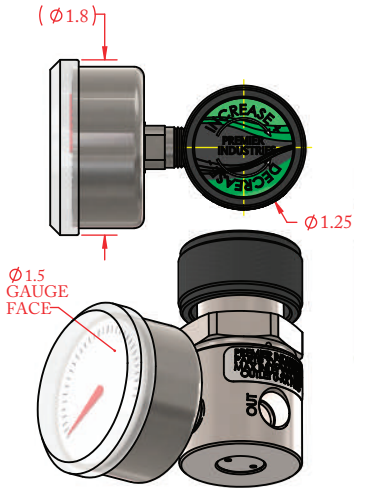

PART NUMBER 50-12771

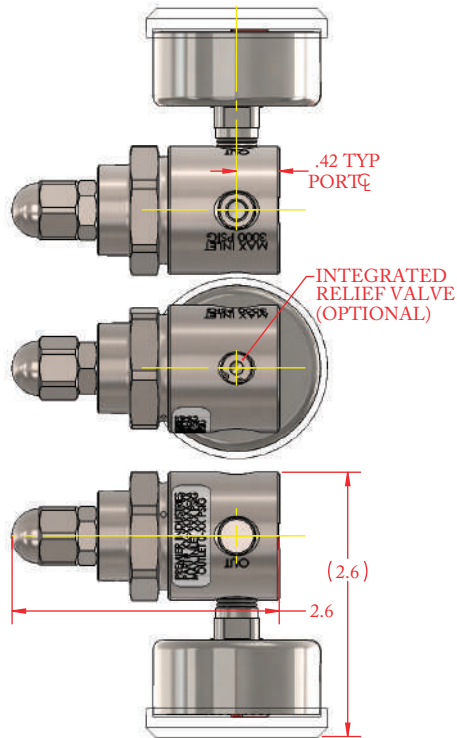
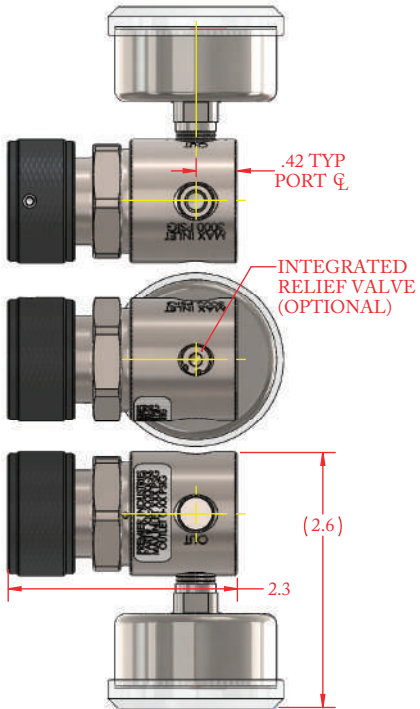
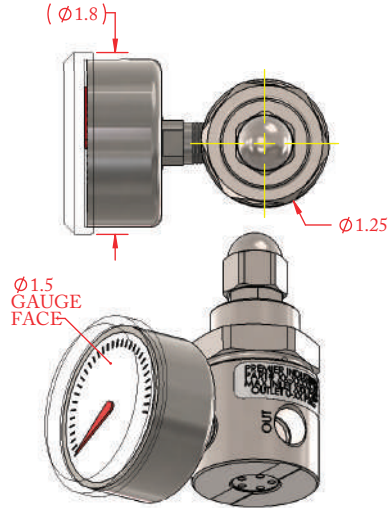

PART NUMBER 50-12908

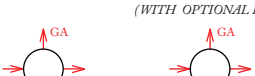
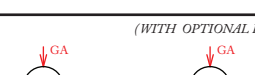
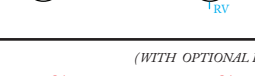
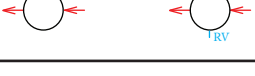

PART #	-	1	2	-	3	-	4	5	-	MODS
50-12771	-			-		-			-	



1	BODY/BONNET MATERIALS (MAX. INLET PRESSURE)	
1	SAE 360 Brass, Nickel Plated (body & bonnet)	
5	316 Stainless Steel, cleaned per spec #515 (body) SAE 360 Brass, Nickel Plated (bonnet)	
7	316 Stainless Steel, cleaned per spec #515 (body) 316 Stainless Steel, cleaned per spec #515 (bonnet)	
2	BODY PORTING	
A	A porting, 3 port	 (WITH OPTIONAL RELIEF VALVE)
B	B porting, 3 port	 (WITH OPTIONAL RELIEF VALVE)
G	G porting, 3 port	 (WITH OPTIONAL RELIEF VALVE)
H	H porting, 3 port	 (WITH OPTIONAL RELIEF VALVE)
L	L porting, 4 port	 RELIEF VALVE NOT AVAILABLE ON L PORTING CONFIGURATION
S	S porting, 2 port	 (WITH OPTIONAL RELIEF VALVE)

3	OUTLET PRESSURE	RELIEF PRESSURE IF APPLICABLE
1	0-15 psig (0-1.03 bar)	60 psig (4.14 bar)
2	0-30 psig (0-2.07 bar)	60 psig (4.14 bar)
3	0-50 psig (0-3.45 bar)	90 psig (6.21 bar)
4	0-75 psig (0-5.17 bar)	90 psig (6.21 bar)
5	0-100 psig (0-6.89 bar)	relief valve not available
4	GAUGES	
0	None	
1	Include gauges*	
<p>*Gauges not available for 'S' porting configuration, *Both inlet & outlet gauge on 'L' porting configuration *Outlet gauge only on 'A' and 'B' porting configurations *Inlet gauge only on 'G' and 'H' porting configurations</p>		
5	INTEGRATED RELIEF VALVE OPTIONAL	
0	No relief valve	
1	Include relief valve**	
<p>**Relief valve not available on 'L' porting configuration. **Relief valve not available if max outlet > 75 psig.</p>		
MODIFICATIONS		
BLANK	Expected max supply > 1500 PSIG	
L	Expected max supply < 1500 PSIG* <i>*does not reduce pressure rating, optimizes performance for expected supplies under 1500 PSIG</i>	

Contact factory for material certifications. Fees may apply.

PART #	-	1	2	-	3	4	-	PRESET OUTLET
50-12908	-			-			-	

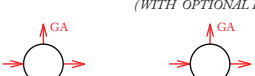
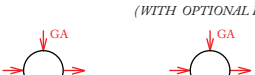
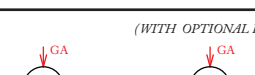
PRESET OUTLET PRESSURE

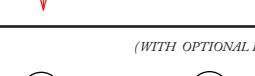
1	BODY/BONNET MATERIALS (MAX. INLET PRESSURE)	
1	SAE 360 Brass, Nickel Plated (body & bonnet)	
5	316 Stainless Steel, cleaned per spec #515 (body) SAE 360 Brass, Nickel Plated (bonnet)	
7	316 Stainless Steel, cleaned per spec #515 (body) 316 Stainless Steel, cleaned per spec #515 (bonnet)	
2	BODY PORTING	
A	A porting, 3 port	
B	B porting, 3 port	
G	G porting, 3 port	
H	H porting, 3 port	
L	L porting, 4 port	
S	S porting, 2 port	

3	GAUGES
0	None
1	Include gauges*
<p><i>*Gauges not available for 'S' porting configuration, *Both inlet & outlet gauge on 'L' porting configuration *Outlet gauge only on 'A' and 'B' porting configurations *Inlet gauge only on 'G' and 'H' porting configurations</i></p>	
4	INTEGRATED RELIEF VALVE OPTIONAL
0	No relief valve
1	Include relief valve**
<p><i>**Relief valve not available on 'L' porting configuration. **Relief valve not available if max outlet > 75 psig.</i></p>	
PRESET OUTLET PRESSURE (XXX)	
XXX	Specify outlet pressure preset 'XXX' in psig. Minimum 10 psig ('010'). Maximum 150 psig ('150')
<p>IF REGULATOR INCLUDES A RELIEF VALVE, RELIEF SETTINGS ARE AS FOLLOWS: <i>'XXX' ≤ 30 PSIG OUT / 60 PSIG RELIEF SETTING 30 < 'XXX' ≤ 75 PSIG OUT / 90 PSIG RELIEF SETTING</i></p> <p>OUTLET SET AT 2000 PSIG INLET (UNLESS NOTED OTHERWISE ON WORK ORDER.)</p>	

Contact factory for material certifications. Fees may apply.